



FLASH

Davide Groppi / 2017

It is our Infinito model turned around, with the light flowing downwards.
The 9 mm wide stainless steel strip can run perfectly up to 36 metres in length
(standard versions at 6 / 12 / 18 metres in length).

The ideal solution for direct illumination of spaces with very high ceilings.

Its name pays homage to the famous comic book superhero.

Who can run seven times the speed of light.

Flash in its versions of 6 and 12 meters can be integrated with our Endless system.

È la declinazione del nostro modello Infinito, ma con la luce diretta verso il basso.

Il nastro in acciaio inossidabile, largo 9 millimetri, può essere teso perfettamente fino a 36
metri di lunghezza (lampada standard 6 / 12 / 18 metri).

La soluzione ideale per l'illuminazione diretta di spazi con grande altezza.

Il nome è un omaggio al leggendario supereroe dei fumetti.

Famoso perché corre sette volte più veloce della luce...

Flash 6 e Flash 12 sono integrabili con il nostro sistema Endless.

How to order - FLASH 6

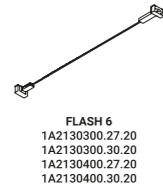

FLASH 6
1A2130300.27.20
1A2130300.30.20
1A2130400.27.20
1A2130400.30.20

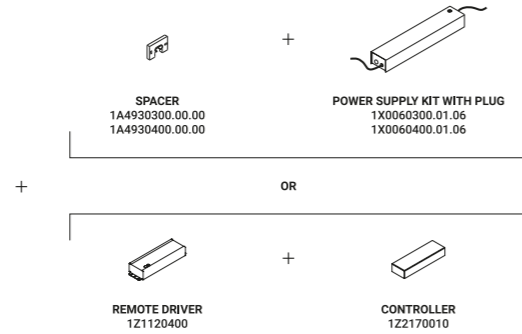

How to order - FLASH 12

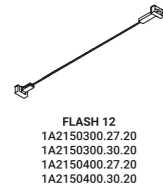

FLASH 12
1A2150300.27.20
1A2150300.30.20
1A2150400.27.20
1A2150400.30.20

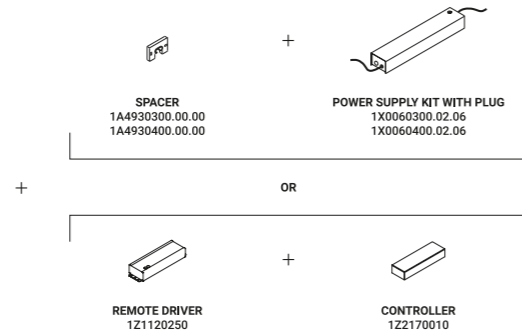

How to order - FLASH 18

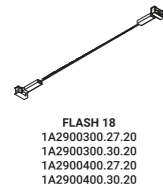

FLASH 18
1A2900300.27.20
1A2900300.30.20
1A2900400.27.20
1A2900400.30.20



Wall-Systems / Direct / Indoor

Material Metal
Finish .03 Matt White .04 Matt Black

Note LED module 6/12/18 m long available with double emission - LED module 5/10 m long with Tunable White technology available with double emission - Harmonic steel strip 10 mm wide - Can be cut every 96,6 mm - FLASH 6 and FLASH 12: luminaires designed to be powered by ENDLESS system.
Modulo LED lunghezza 6/12/18 m disponibile a doppia emissione - Modulo LED lunghezza 5/10 m con tecnologia Tunable White disponibile a doppia emissione - Nastro in acciaio armonico larghezza 10 mm - Sezionabile ogni 96,6 mm - FLASH 6 e FLASH 12: apparecchi predisposti per essere alimentati dal sistema ENDLESS.

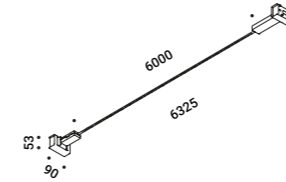

FLASH 6
Length 6000 mm
57W
48V DC
2700K - 6576lm / 3000K - 6708lm
CRI >90
Driver not included
CE IP20 E

Matt White - 2700K	1A2130300.27.20
Matt White - 3000K	1A2130300.30.20
Matt Black - 2700K	1A2130400.27.20
Matt Black - 3000K	1A2130400.30.20

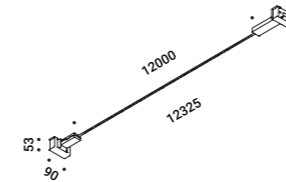

FLASH 12
Length 12000 mm
114W
48V DC
2700K - 13152lm / 3000K - 13416lm
CRI >90
Driver not included
CE IP20 E

Matt White - 2700K	1A2150300.27.20
Matt White - 3000K	1A2150300.30.20
Matt Black - 2700K	1A2150400.27.20
Matt Black - 3000K	1A2150400.30.20

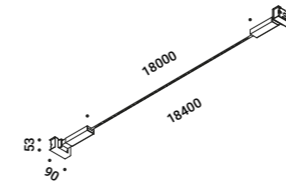

FLASH 18
Length 18000 mm
171W
48V DC
2700K - 19728lm / 3000K - 20124lm
CRI >90
Driver not included
CE IP20

Matt White - 2700K	1A2900300.27.20
Matt White - 3000K	1A2900300.30.20
Matt Black - 2700K	1A2900400.27.20
Matt Black - 3000K	1A2900400.30.20

How to order -
FLASH 6 DE

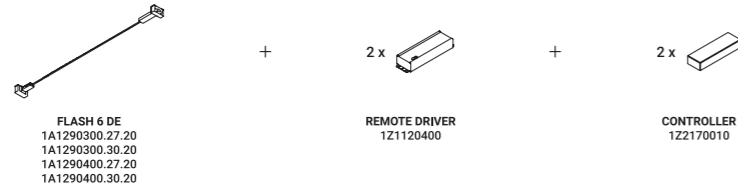

How to order -
FLASH 12 DE

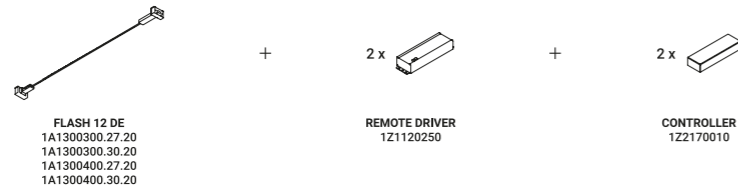

How to order -
FLASH 18 DE

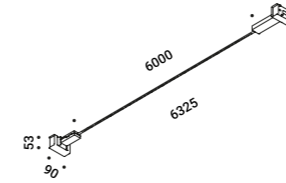
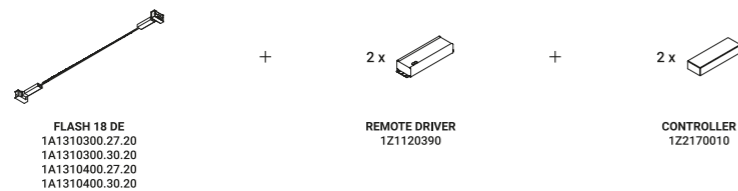

FLASH 6 DE

Length 6000 mm -
Double output and double switch
114W
48V DC
2700K - Up 6576lm - Down 6576lm /
3000K - Up 6708lm - Down 6708lm
CRI >90
Driver not included

CE IP20

Matt White - 2700K
Matt White - 3000K
Matt Black - 2700K
Matt Black - 3000K

1A1290300.27.20
1A1290300.30.20
1A1290400.27.20
1A1290400.30.20

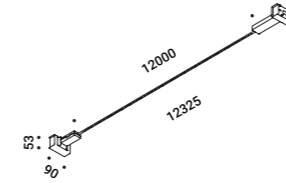

FLASH 12 DE

Length 12000 mm -
Double output and double switch
228W
48V DC
2700K - Up 13152lm - Down 13152lm /
3000K - Up 13416lm - Down 13416lm
CRI >90
Driver not included

CE IP20

Matt White - 2700K
Matt White - 3000K
Matt Black - 2700K
Matt Black - 3000K

1A1300300.27.20
1A1300300.30.20
1A1300400.27.20
1A1300400.30.20

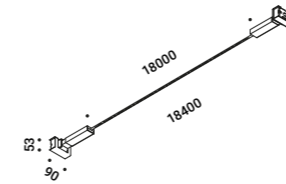

FLASH 18 DE

Length 18000 mm -
Double output and double switch
342W
48V DC
2700K - Up 19728lm - Down 19728lm /
3000K - Up 20124lm - Down 20124lm
CRI >90
Driver not included

CE IP20

Matt White - 2700K
Matt White - 3000K
Matt Black - 2700K
Matt Black - 3000K

1A1310300.27.20
1A1310300.30.20
1A1310400.27.20
1A1310400.30.20

How to order -
FLASH 5 TW

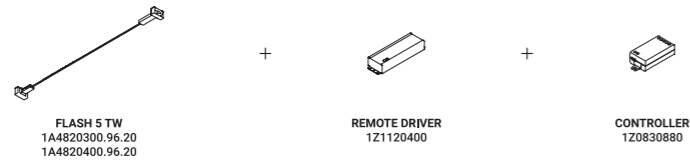

How to order -
FLASH 10 TW

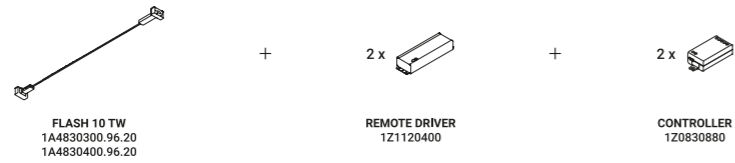

Note Tunable White describes the variable colour temperature controls from warm white to cool white light.
Tunable White è la regolazione variabile della temperatura di colore dalla tonalità calda a quella fredda.

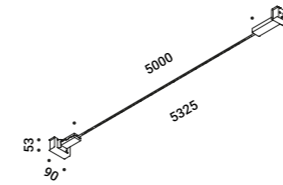

FLASH 5 TW
Length 5000 mm - Tunable White
50W
24V DC
2700/6500K - 7650lm
CRI >90
Driver not included
CE IP20

Matt White - 2700/6500K
Matt Black - 2700/6500K

1A4820300.96.20
1A4820400.96.20

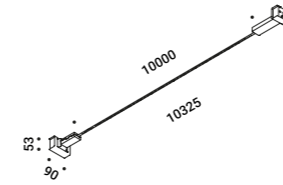

FLASH 10 TW
Length 10000 mm - Tunable White
100W
24V DC
2700/6500K - 15300lm
CRI >90
Driver not included
CE IP20

Matt White - 2700/6500K
Matt Black - 2700/6500K

1A4830300.96.20
1A4830400.96.20

How to order -
FLASH 5 DE TW



FLASH 5 DE TW
1A4840300.96.20
1A4840400.96.20

+



2 x
REMOTE DRIVER
1Z1120400

+



2 x
CONTROLLER
1Z0830880

How to order -
FLASH 10 DE TW

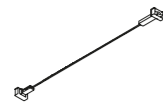

FLASH 10 DE TW
1A4850300.96.20
1A4850400.96.20

+



4 x
REMOTE DRIVER
1Z1120400

+



4 x
CONTROLLER
1Z0830880

Note Tunable White describes the variable colour temperature controls from warm white to cool white light.
Tunable White è la regolazione variabile della temperatura di colore dalla tonalità calda a quella fredda.

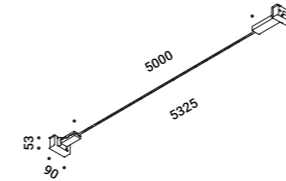

FLASH 5 DE TW
Length 5000 mm -
Double output - Tunable White
100W
24V DC
2700/6500K - 15300lm
CRI >90
Driver not included
CE IP20

Matt White - 2700/6500K
Matt Black - 2700/6500K

1A4840300.96.20
1A4840400.96.20

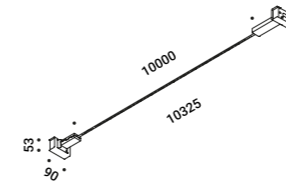

FLASH 10 DE TW
Length 10000 mm -
Double output - Tunable White
200W
24V DC
2700/6500K - 30600lm
CRI >90
Driver not included
CE IP20

Matt White - 2700/6500K
Matt Black - 2700/6500K

1A4850300.96.20
1A4850400.96.20

Compulsory accessories / Accessori obbligatori

Installation kit / Kit installazione



Spacer / Distanziale		Not included	
Matt White	For power supply kit with plug	FLASH 6 / FLASH 12	1A4930300.00.00
Matt Black	For power supply kit with plug	FLASH 6 / FLASH 12	1A4930400.00.00

Electrical power supply / Alimentazione elettrica

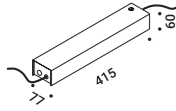

Power supply kit with plug / Kit alimentazione con spina		Not included	
Matt White	Input 100-240V - 50/60Hz - Output 48V - Max 57W - IP20	FLASH 6	1X0060300.01.06
Matt Black	Input 100-240V - 50/60Hz - Output 48V - Max 57W - IP20	FLASH 6	1X0060400.01.06

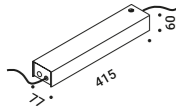

Power supply kit with plug / Kit alimentazione con spina		Not included	
Matt White	Input 100-240V - 50/60Hz - Output 48V - Max 114W - IP20	FLASH 12	1X0060300.02.06
Matt Black	Input 100-240V - 50/60Hz - Output 48V - Max 114W - IP20	FLASH 12	1X0060400.02.06

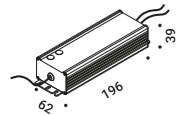

Driver LED		Not included	
100-240V	48V/80W/IP67/1-10V	FLASH 6 / FLASH 6 DE / FLASH 5 TW / FLASH 5 DE TW	1Z1120400

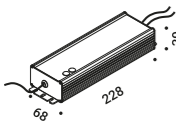

Driver LED		Not included	
100-240V	48V/150W/IP67/1-10V	FLASH 12 / FLASH 12 DE / FLASH 10 TW / FLASH 10 DE TW	1Z1120250

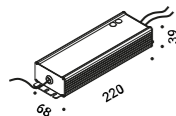

Driver LED		Not included	
100-240V	48V/240W/IP67/1-10V	FLASH 18 / FLASH 18 DE	1Z1120390

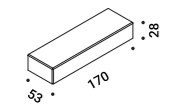

Controller		Not included	
Matt Black	DALI - PUSH - 0/1-10V - TRIAC - IP20	FLASH 6 / FLASH 12 / FLASH 18 / FLASH 6 DE / FLASH 12 DE / FLASH 18 DE	1Z2170010

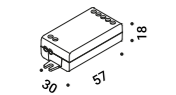

Controller Casambi - Tunable White		Not included	
		FLASH 5 TW / FLASH 10 TW / FLASH 5 DE TW / FLASH 10 DE TW	1Z0830880

Optional accessories / Accessori opzionali

Installation kit / Kit installazione

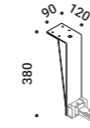

Ceiling connection kit / Kit attacco soffitto		Not included	
Matt Black			1A0080400.00.00



Kit wall connection vertical sloped 45° / Kit attacco parete per inclinazione verticale 45°		Not included	
Matt Black			1A0120400.00.00



Kit wall connection sloped right 75° / Kit attacco parete per inclinazione 75° destro		Not included	
Matt Black			1A0340400.00.00



Kit wall connection sloped left 75° / Kit attacco parete per inclinazione 75° sinistro		Not included	
Matt Black			1A0350400.00.00



Swallows / Rondini		Not included	
Matt Black			1A0800400.00.00

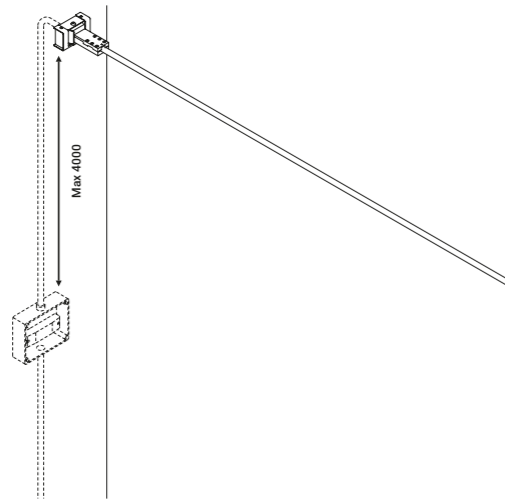

Remote power supply kit

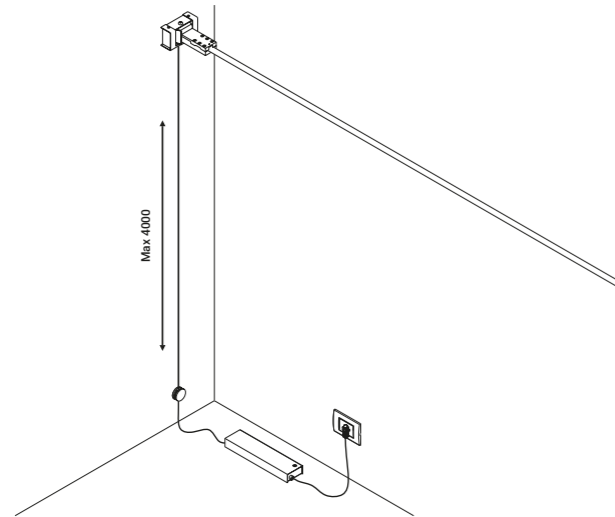

Power supply kit with plug

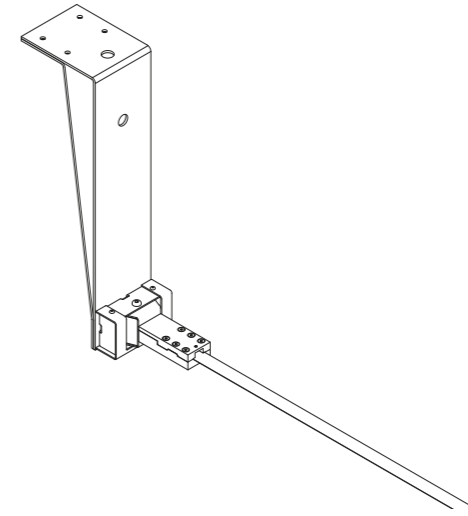

1A0080400.00.00 - Ceiling connection kit

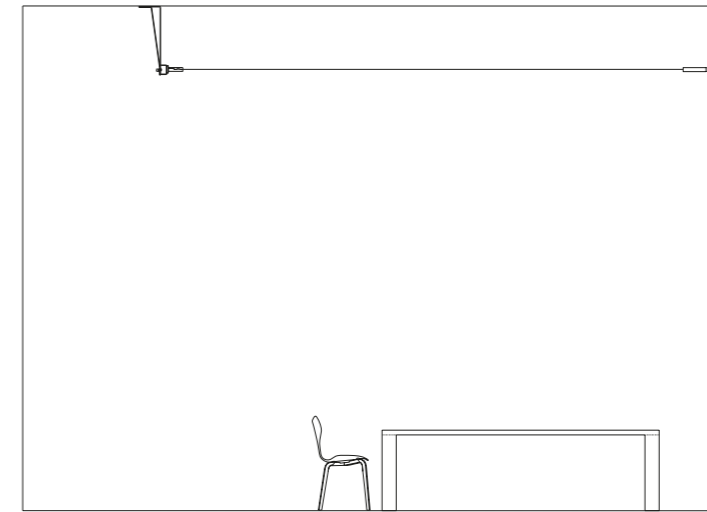

1A0080400.00.00 - Example of installation with ceiling connection kit

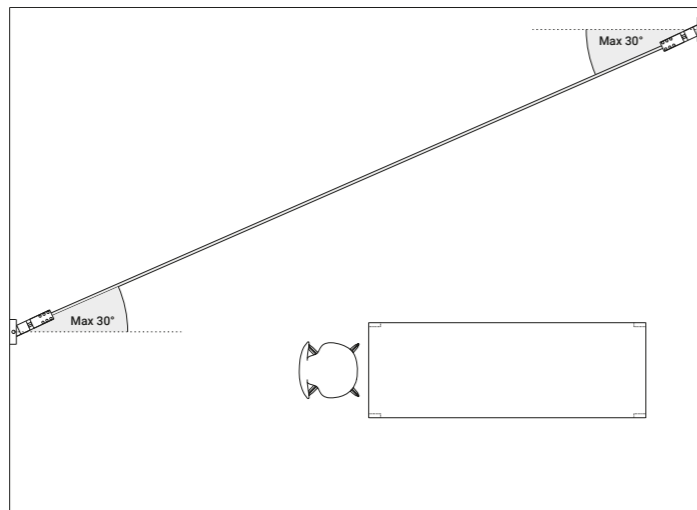

Example of installation with max rotation 30°

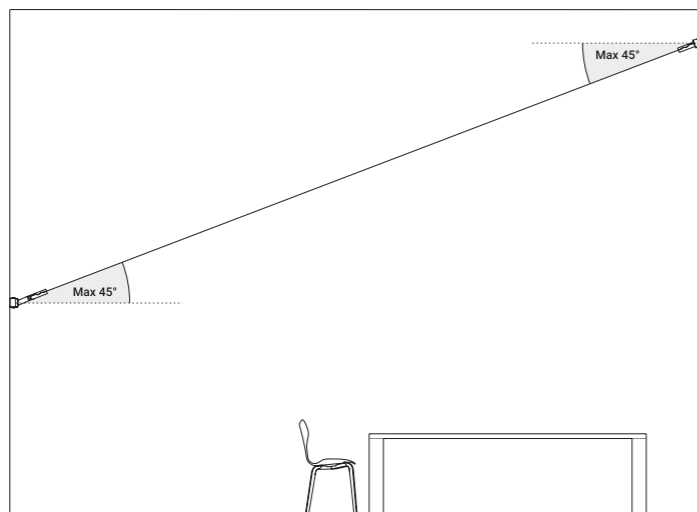

1A0120400.00.00 - Kit wall connection vertical sloped 45°

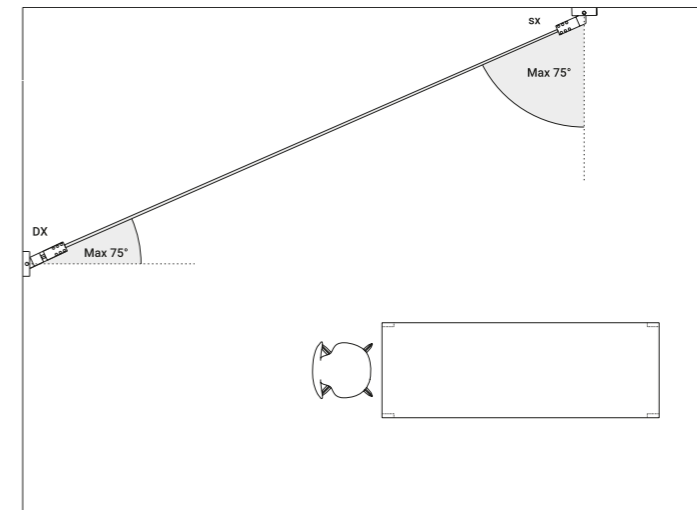

1A0340400.00.00 - 1A0350400.00.00 - Kit wall connection sloped 75°